

Municipalidad de San Luis
Secretaría de Infraestructura

Obra: Puente Peatonal Av. Pte. III
PLANO: Gral. Planta y Vista

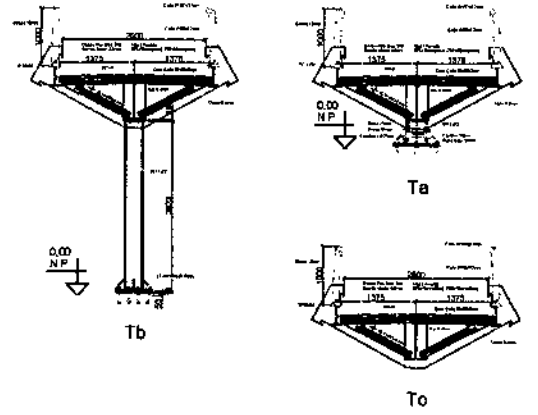

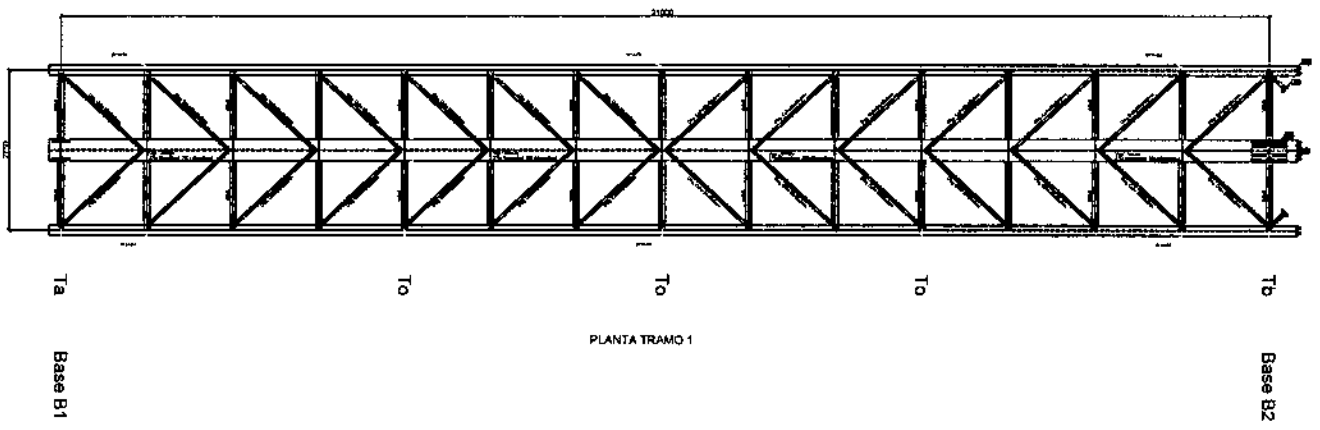
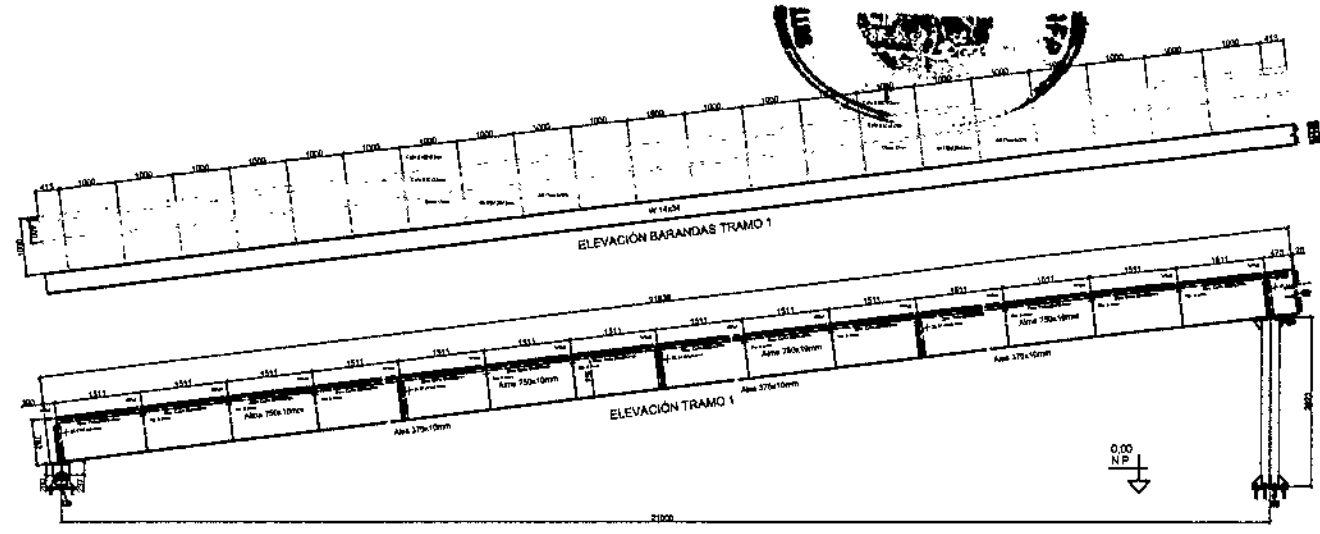

MATERIALES			
Perfiles	Galvalum 750	Tubos Perforados 200	Tubos Perforados 100
Cables Estructurales	Cable 7.50	Tubos Perforados 200	Tubos Perforados 100
Perfiles L	Cable 7.50	Tubos Perforados 200	Tubos Perforados 100
Chapas Aluminio	Cable 7.50	Tubos Perforados 200	Tubos Perforados 100
Relevos Puentes	Cable 7.50	Tubos Perforados 200	Tubos Perforados 100

Municipalidad de San Luis
Secretaría de Infraestructura

Obra: Puente Peatonal Av. Pte. San Luis
PLANO: Estructura - Detalles - T-1

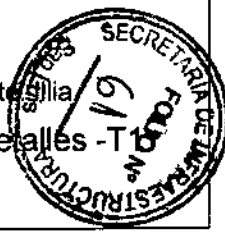

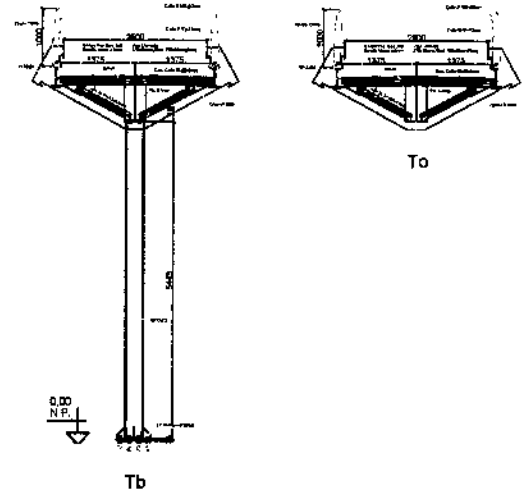
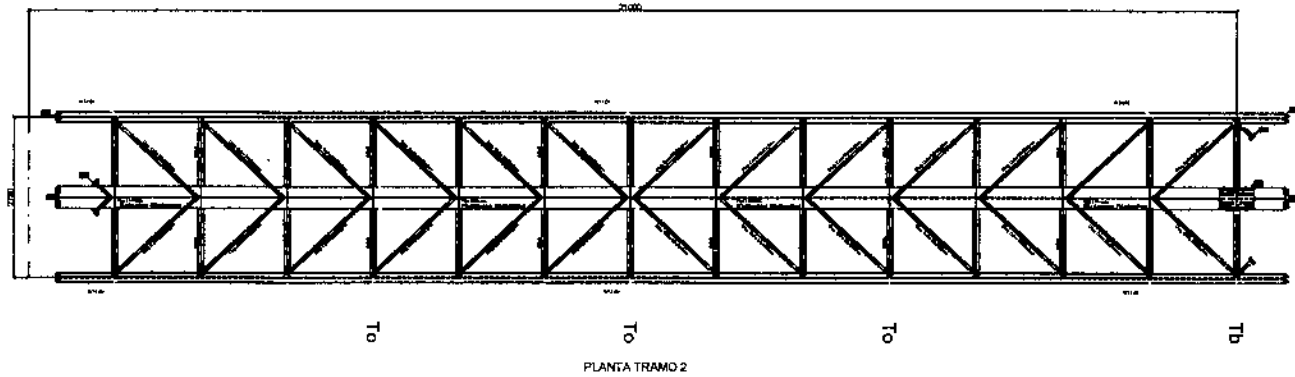
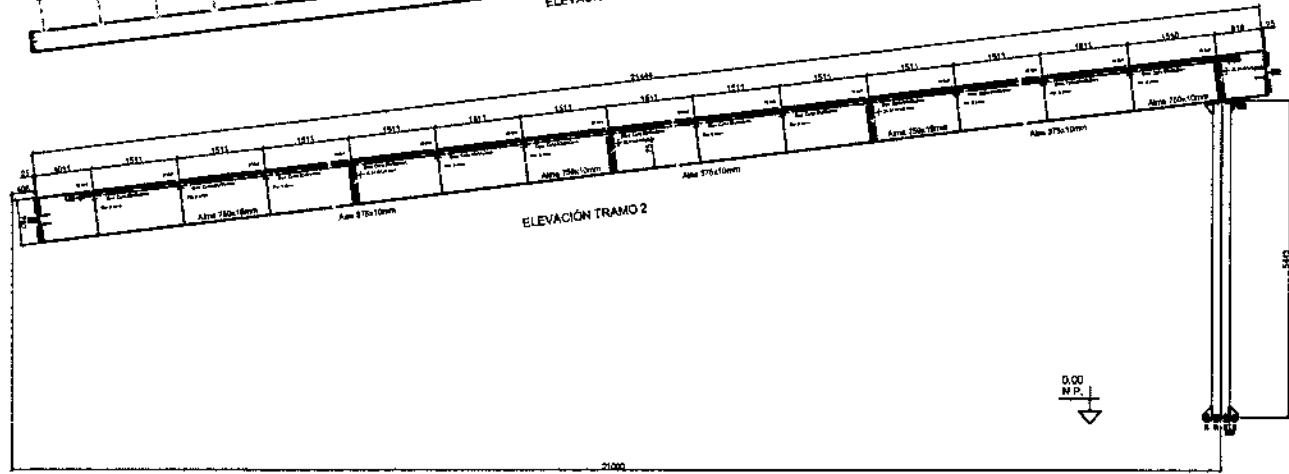
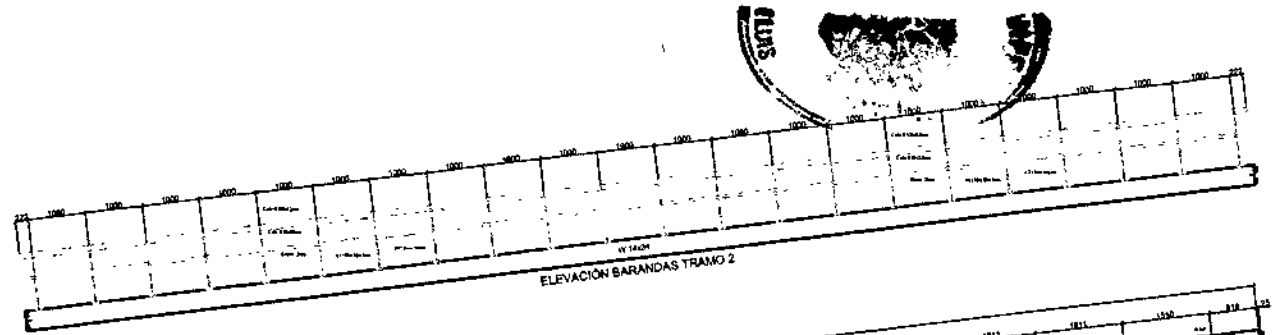

MATERIAL			
Perfiles	Caldesi 120	Tornillos Perforados 10	Tornillos Redondos 10
Cables Carabinados	Caldesi 120	Tornillos Perforados 20	Tornillos Redondos 20
Puercas	Caldesi 120	Tornillos Perforados 20	Tornillos Redondos 20
Chapas Niples	Caldesi 120	Tornillos Redondos 10	Tornillos Redondos 10
Botones Pernos	Caldesi 120	T. Abre Tornillos 100	T. Abre Cortes 100

Municipalidad de San Luis
Secretaría de Infraestructura

Obra: Puente Peatonal Av. Pte. Illija

PLANO: Estructura - Detalles -



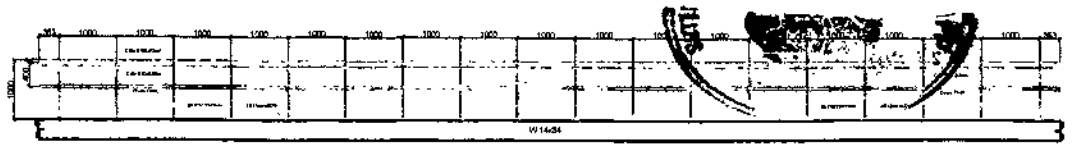

ELEVACIÓN BARANDAS TRAMO 3

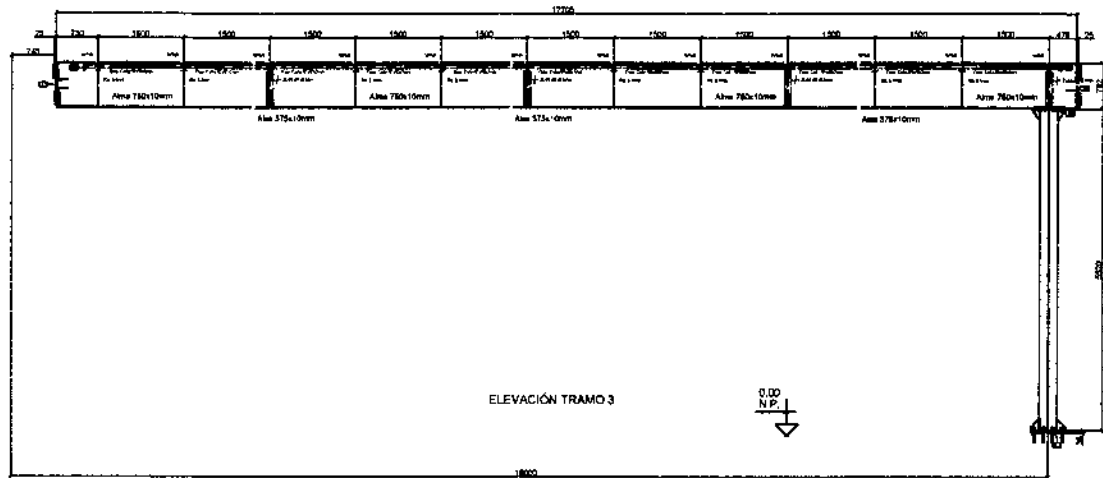

ELEVACIÓN TRAMO 3

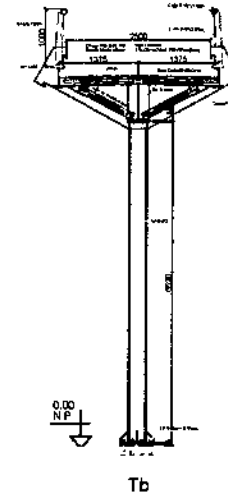

Tb

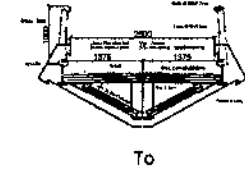

To

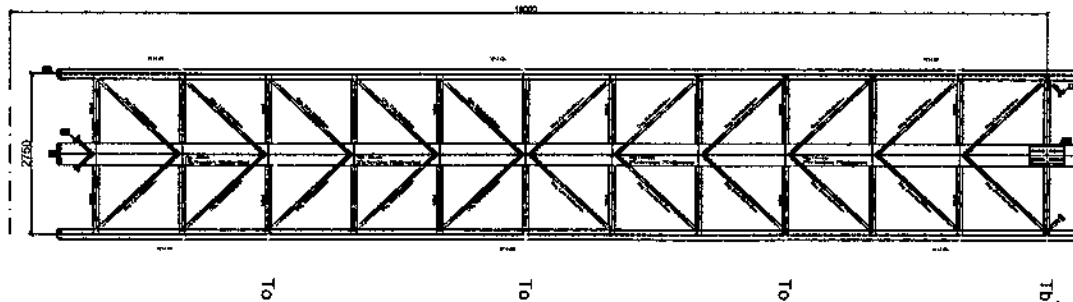

PLANTA TRAMO 3

REVISIÓN			
Por: M. B.	Calculo: F. B.	Tramite: T. P. M. S. S.	Tramite: T. P. M. S. S.
Caro: E. B.	Calculo: F. B.	Tramite: T. P. M. S. S.	Tramite: T. P. M. S. S.
Por: M. B.	Calculo: F. B.	Tramite: T. P. M. S. S.	Tramite: T. P. M. S. S.
Por: M. B.	Calculo: F. B.	Tramite: T. P. M. S. S.	Tramite: T. P. M. S. S.

Municipalidad de San Luis
Secretaria de Infraestructura

Obra: Puente Peatonal Av. Pte. 101

PLANO: Estructura - Detalles - T3





ELEVACIÓN BARANDA TRAMO 4

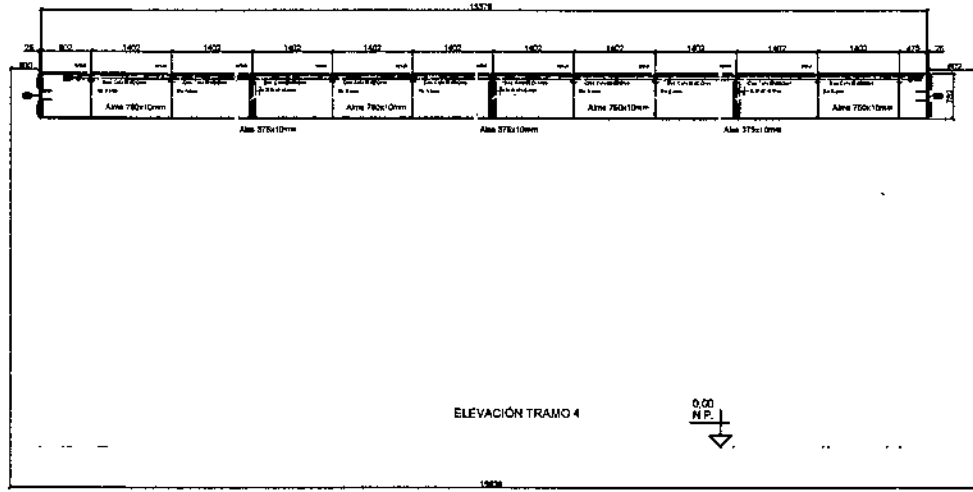

ELEVACIÓN TRAMO 4

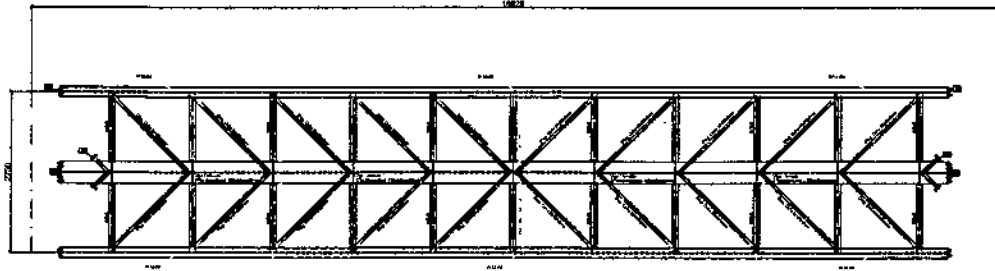

PLANTA TRAMO 4

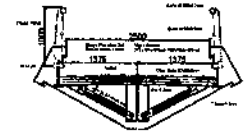

To

MATERIALES		
Perfiles V	Calado 2" x 2"	Tornillos Plancha 200 N
Canes Elevadores	Calado 2" x 2"	Tornillos Plancha 200 N
Perfiles L	Calado 2" x 2"	Tornillos Plancha 200 N
Canes Aljeas	Calado 2" x 2"	Tornillos Plancha 200 N
Alambres Perforados	Calado 2" x 2"	Tornillos Plancha 200 N

Municipalidad de San Luis
Secretaría de Infraestructura

Obra: Puente Peatonal Av. Pte.

PLANO: Estructura - Detalles



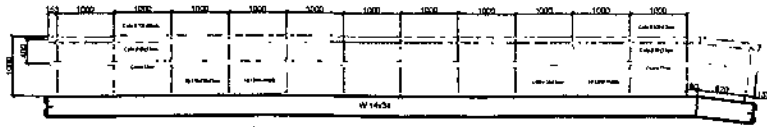

ELEVACIÓN BARANDAS TRAMO 6 DESARROLLO (EXT)

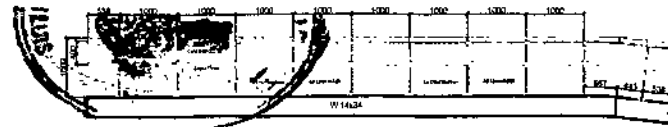

ELEVACIÓN BARANDAS TRAMO 5 DESARROLLO (INT)

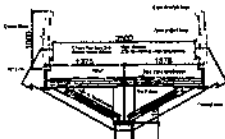

Td

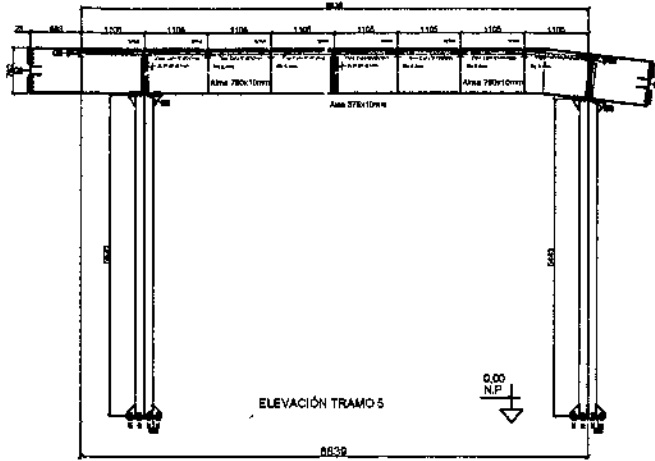

ELEVACIÓN TRAMO 5

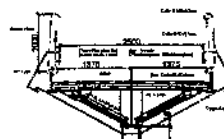

Tb

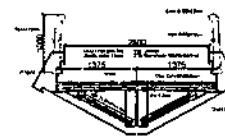

To

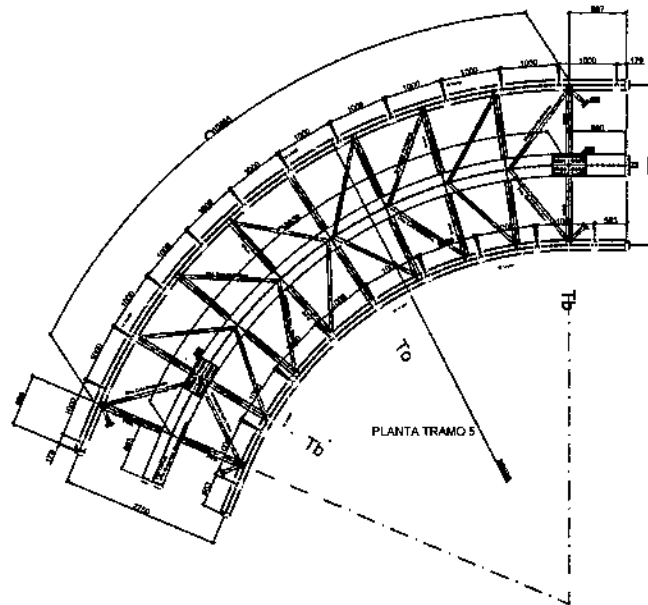

PLANTA TRAMO 5

MATERIALES			
Perfil H	C-200 x 20	Tubo de Acero 483 x 3	Tubo de Acero 483 x 3
Cable de Aluminio	1/2" x 19	Tubo de Acero 483 x 3	Tubo de Acero 483 x 3
Perfora	C-200 x 20	Tubo de Acero 483 x 3	Tubo de Acero 483 x 3
Chapa de Acero	C-200 x 20	Tubo de Acero 483 x 3	Tubo de Acero 483 x 3
Rebeldes de Acero	C-200 x 20	Tubo de Acero 483 x 3	Tubo de Acero 483 x 3

Municipalidad de San Luis
Secretaria de Infraestructura

Obra: Puente Peatonal Av. Pte. Ullija

PLANO: Estructura - Detalles

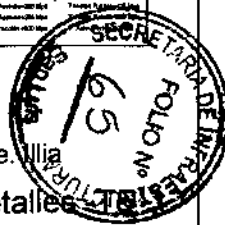

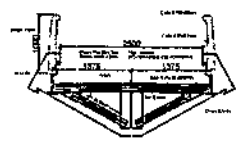
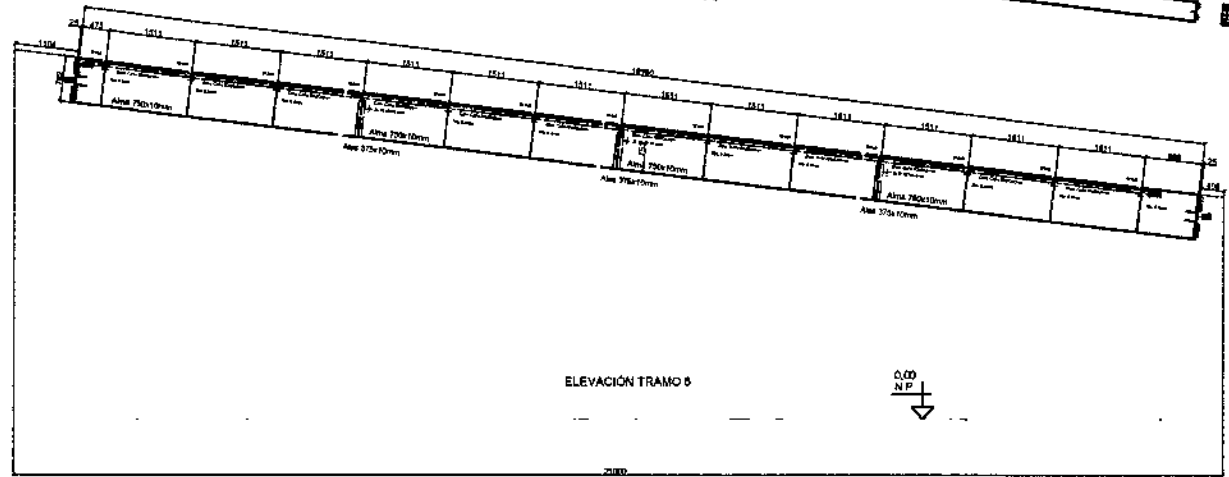
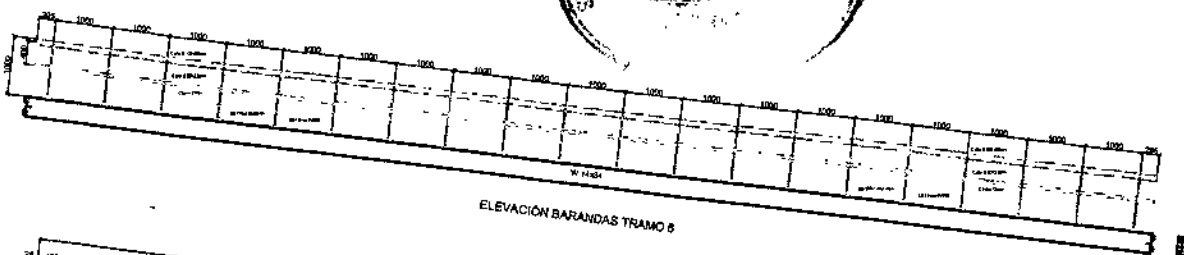
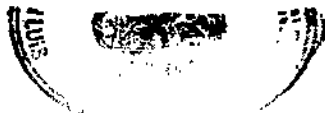

To

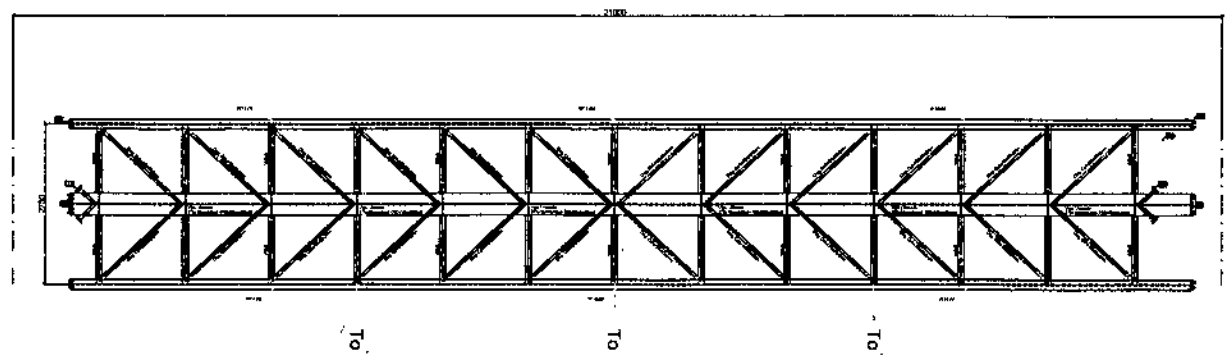

PLANTA TRAMO 6

MATERIALS		
Columnas	Cemento F-30	Travieso Perforado 100x100
Cables de Anclaje	Cable F-54	Travieso Perforado 100x100
Perfiles	Cable F-54	Travieso Perforado 100x100
Alambres	Cable F-54	Travieso Perforado 100x100
Alambres	Cable F-54	Travieso Perforado 100x100

Municipalidad de San Luis
Secretaría de Infraestructura

Obra: Puente Peatonal Av. Pte. Itia

PLANO: Estructura - Detalles T6



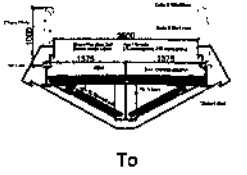
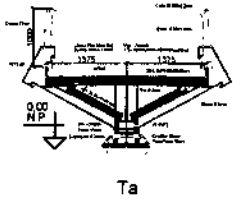
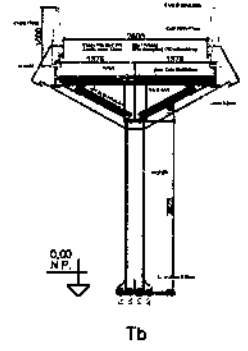
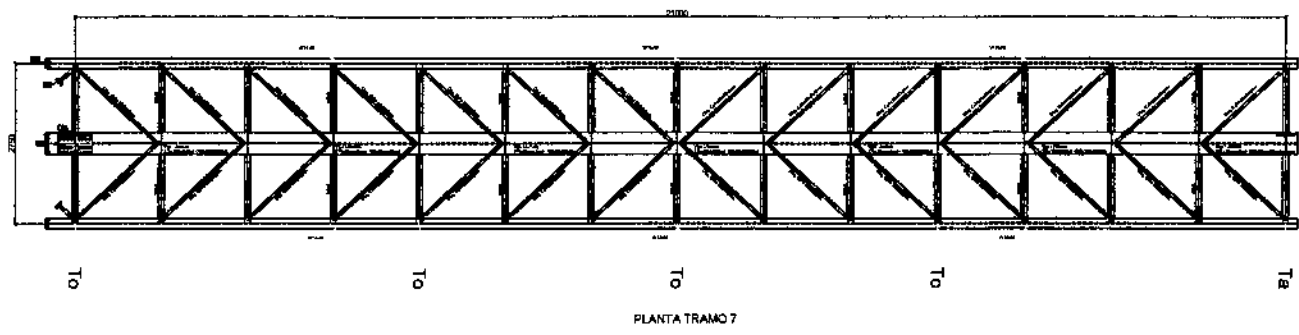
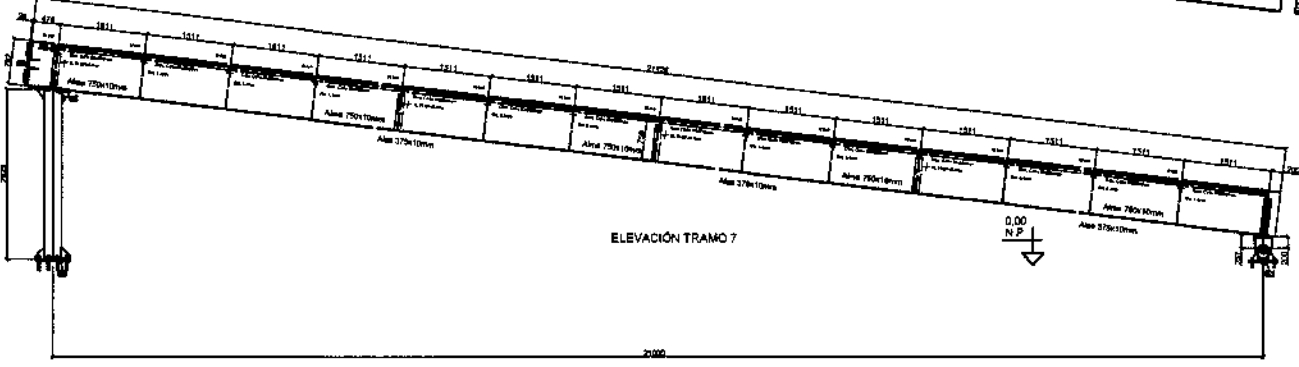
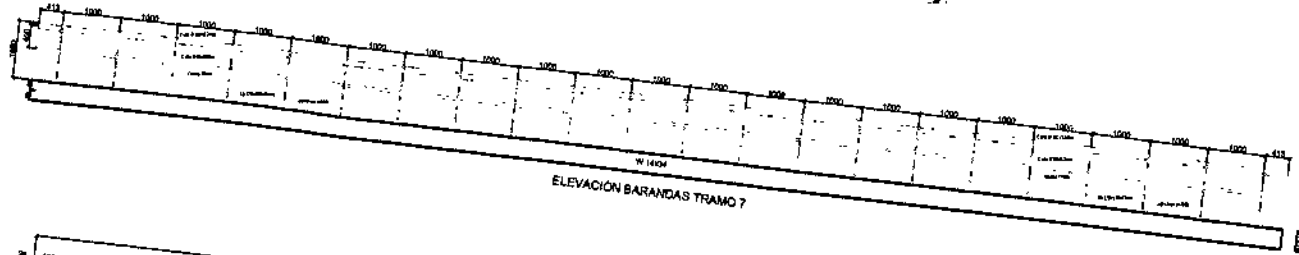

AUTORIZACIONES		
Proyecto	Edificio F-31	Tercera Promoción-08/08/08
Calidad Ejecución	Calidad F-31	Tercera Promoción-08/08/08
Proyecto	Calidad F-31	Tercera Promoción-08/08/08
Calidad Ejecución	Calidad F-31	Tercera Promoción-08/08/08
Proyecto	Calidad F-31	Tercera Promoción-08/08/08
Calidad Ejecución	Calidad F-31	Tercera Promoción-08/08/08

Municipalidad de San Luis
 Secretaria de Infraestructura
 Obra: Puente Peatonal Av. Pte. Villia
 PLANO: Estructura - Detalles



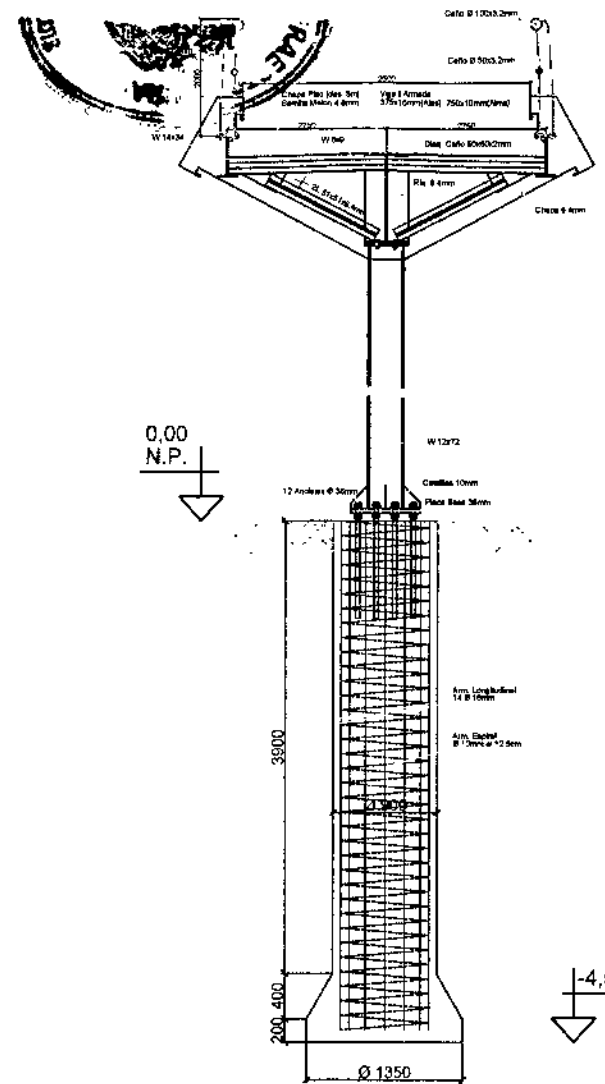

Protección Colisión
Cant: 6

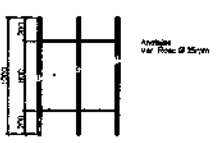
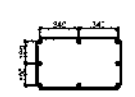
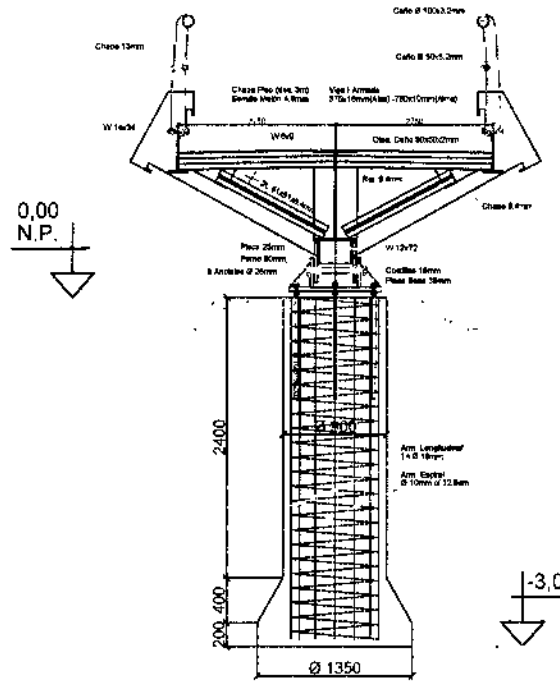
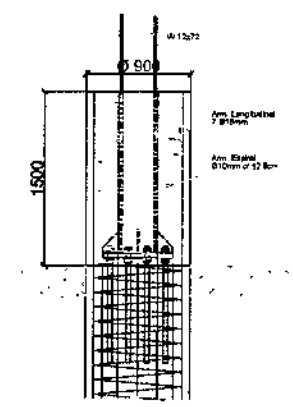
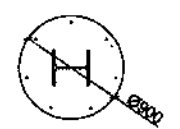

Anclajes A1
cant=2 (Juegos)

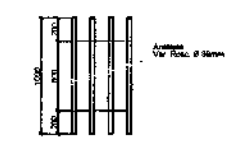
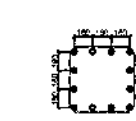

Anclajes A2
cant=6 (Juegos)

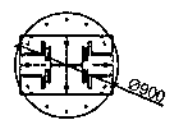

Base B1
Cant: 2

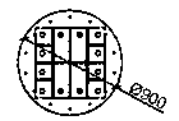

Base B2
Cant: 6

MATERIALS			
Design Code	W 11	Technical Commission Code	Spanish Standard (EN)
Design and Approval	ADN-438	Technical Provision Code	
Project Name	080447-2-1	Technical Provision Code	

Municipalidad de San Luis
Secretaria de Infraestructura

Obra: Puente Peatonal Av. Pte. Niza
PLANO: Fundaciones - Anclajes

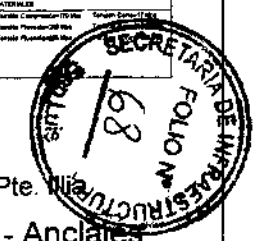

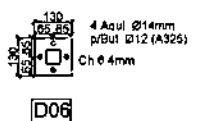
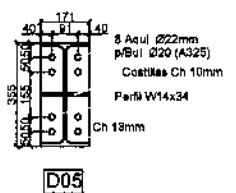
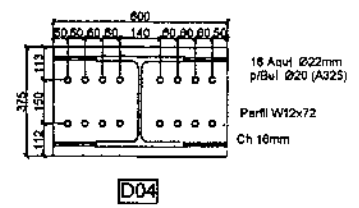
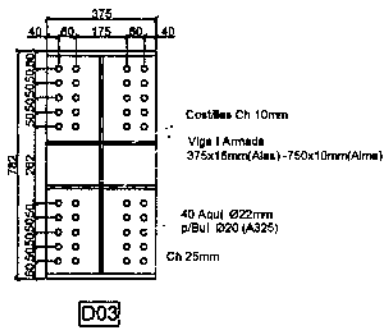
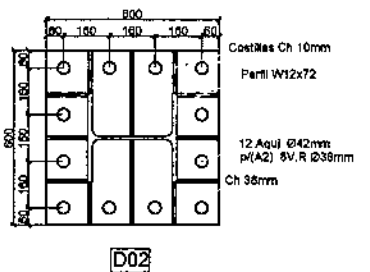
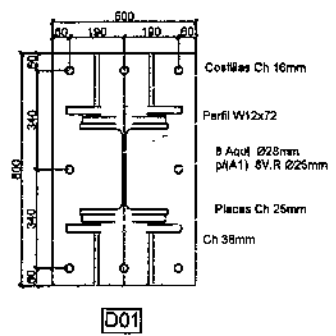
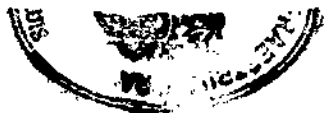

AUTORIZADO			
Proyecto	Calidad P-21	Tamaño Formato-300 Nps	Escala Formato-20 Nps
Carro Estacionado	Calidad P-21	Tamaño Formato-25 Nps	Escala Formato-20 Nps
Puentes	Calidad P-21	Tamaño Formato-25 Nps	Tamaño Formato-20 Nps
Plano de Sitio	Calidad P-21	Tamaño Formato-25 Nps	Tamaño Formato-20 Nps
Informe Final	Calidad A325	Tamaño Formato-400 Nps	Tamaño Formato-20 Nps

Municipalidad de San Luis
 Secretaria de Infraestructura

Obra: Puente Peatonal Av. P...
 PLANO: Detalles

